

**FeliCa Reader/Writer**  
**Digital Protocol Requirements Specification**

Version 1.1  
January 18, 2019

Japan Electronic-money Promotion Association

## Revision History

Version No.	Date issued	Description of Revisions
1.0	October 05, 2017	First edition
1.1	January 18, 2019	Section 4, 5.3, 6.3, 6.5 are changed. Section 6.10 is added. Attachment A is changed.

# Contents

Preface .....	4
1. Purpose of the Requirements .....	4
2. Status of the Requirements .....	4
3. Products to be tested .....	4
3.1. Products subject to testing.....	4
3.2. Product models to be tested .....	4
4. Item to be submitted.....	4
5. How to proceed.....	5
5.1. Relationship with the FeliCa RF performance certification test .....	5
5.2. Place of evaluation .....	5
5.3. Instruments to be used for evaluation .....	5
6. Details of the Requirements.....	6
6.1. Bit rate for checking the Requirements.....	6
6.2. Reference standards .....	6
6.3. Definition of the terms .....	6
6.4. Categories and scope of evaluations .....	6
6.5. Digital protocol Requirements to be checked .....	7
6.6. Coding system.....	8
6.6.1. Target to be checked.....	8
6.6.2. Devices to be used for evaluation .....	8
6.6.3. Requirements .....	8
6.6.4. Measurement procedure.....	8
6.7. Command format for only enabling e-money payments.....	10
6.7.1. Target to be checked.....	10
6.7.2. Devices to be used for evaluation .....	10
6.7.3. Format of the request command.....	10
6.8. Command format for enabling e-money payments and performing peer-to-peer communication based on NFC-DEP(F) .....	12
6.8.1. Target to be checked.....	12
6.8.2. Devices to be used for evaluation .....	12
6.8.3. Format of the request command.....	12
6.8.4. Format of a response .....	12
6.9. Guard time .....	14
6.9.1. Target to be checked.....	14
6.9.2. Devices to be used for evaluation .....	14
6.9.3. Requirements .....	14
6.9.4. Measurement procedure.....	14
6.10. Frame structure .....	15
6.10.1. Target to be checked.....	15
6.10.2. Devices to be used for evaluation .....	15
6.10.3. Requirements .....	15
6.10.4. Measurement procedure.....	19
Attachment A: Digital protocol requirements check sheet.....	20

## **Preface**

This document specifies the FeliCa Reader/Writer digital protocol requirements (abbreviated to as *the Requirements* hereafter) to be implemented on the FeliCa-compatible Reader/Writer.

The Requirements concern only the digital protocol for the Reader/Writer products and not other matters including RF. See below for the details, methods, standards, evaluation environments, and procedures for the Requirements.

The Requirements are defined based on the results of the discussion held at the Japan Electronic-money Promotion Association.

### **1. Purpose of the Requirements**

The purpose of the Requirements is to create an environment in which service providers and end users feel secure and have a positive experience with services that use FeliCa technology. To that end, we will use the requirement process to establish shared Digital Protocol standards for equipment and systems to achieve better interconnectivity between FeliCa devices.

### **2. Status of the Requirements**

The standards set forth in the Requirements do not certify the interoperability of marketed FeliCa equipment.

The Requirements are used only to check whether the samples of a product satisfy the Requirements before an applicant manufacturer submits the product to the FeliCa Reader/Writer RF Performance Certification Test.

Warranties on the products tested shall conform to the warranty conditions originally established by the individual manufacturers.

### **3. Products to be tested**

#### **3.1. Products subject to testing**

The Requirements are for FeliCa-compatible Reader/Writer products.

#### **3.2. Product models to be tested**

Each applicant manufacturer shall check whether each model of each product to be tested meets the Requirements.

### **4. Item to be submitted**

The evaluation of this requirement includes the overlap with technical requirements and test cases conducted by the NFC Forum. The NFC Forum is the international standards organization for NFC technology. For the purpose of reducing an excessive burden on the applicant manufacturers, duplicate test items are allowed to inherit passing results from the NFC Forum test and be treated as passing for the Requirements.

For the devices certified by the NFC Forum, please submit the following two documents.

1. Copy of a Letter of Approval for the NFC Forum certified devices
2. FeliCa Reader/Writer Digital Protocol Requirements Check Sheet (abbreviated to as *the Requirements Check Sheet* hereafter).

For other products, please submit the following.

1. FeliCa Reader/Writer Digital Protocol Requirements Check Sheet (the Requirements Check Sheet).

## 5. How to proceed

### 5.1. Relationship with the FeliCa RF performance certification test

If the digital protocol of your product satisfies the Requirements, you can take the FeliCa RF Performance Certification Test.

### 5.2. Place of evaluation

The Requirements shall be voluntarily checked by an applicant manufacturer and the results shall be written into the Requirements Check Sheet. The Requirements Check Sheet shall be submitted to the test site when you apply for the FeliCa RF Performance Certification Test.

### 5.3. Instruments to be used for evaluation

Configure an arrangement of instruments for checking the Requirements to best suit your evaluation environment.

An example arrangement of instruments is as follows:

- Instruments that can analyze modulated signals (abbreviated to as *instruments* hereafter)
  - Test tools for the NFC Forum Digital Protocol Certification Test or any equivalent instruments
  - Digital protocol tester
  - Oscilloscope and others
- Probe or antenna for observing wireless interface (abbreviated to as *probe* hereafter)
- Frame Configuration Assessment Jig (abbreviated to as *DP TestBoard* hereafter)
  - USB cable (one terminal is USB MicroB)
  - Test application that sends commands according to the sequence in 6.10.3

## 6. Details of the Requirements

### 6.1. Bit rate for checking the Requirements

All evaluations shall be performed at the bit rate of 212 kbps.

### 6.2. Reference standards

The latest versions of the following standards shall be referenced as needed.

\*1 JIS X 6319-4 Specification of implementation for integrated circuit(s) cards – Part 4: High speed proximity cards, JIS

\*2 NFC Forum Digital Protocol Technical Specification, NFC Forum, Inc.

### 6.3. Definition of the terms

The following table defines the terms used in this specification.

Term	Synonym	Definition
<i>etu</i>	bd *2	Unit of transmission time for bit rate *1. 1 <i>etu</i> = 128 / (2 x 13.56 MHz) for 212 kbps communications
IDm	PICC identifier *1 and NFCID2 *2	Manufacture ID
NFC-DEP(F)		Peer-to-peer communication mode based on the FeliCa communication method among several types of communications that support the NFC Data Exchange Protocol *2
NFC Forum Certified device		Acceptable products of Universal Device *[2] certification test or the Reader Device *[2] certification test conducted by the NFC Forum
Polling command	REQ command (request command) *1 and SENSEF_REQ *2	A command sent by the Reader/Writer to capture and identify the communication target card
Polling response	REQ response, ATQ (Answer To Request) *1, and SENSEF_RES *2	A response is returned from an IC card or an NFC-DEP(F) device when it receives the Polling command and satisfies the requirements defined for the Polling response.
T3T		Abbreviation for Type 3 Tag. A T3T can be an IC card that conforms to JIS X 6319-4 or a device that supports Card Emulation mode or NDEF (NFC Data Exchange Format) *2.

### 6.4. Categories and scope of evaluations

Category	Scope of evaluation
M	Mandatory: An evaluation is mandatory if the product to be tested handles e-money payments.
C	Conditional: An evaluation is mandatory if the product to be tested handles e-money payments and supports NFC-DEP(F).

## 6.5. Digital protocol Requirements to be checked

Section	Item to be checked	Relevant section in the standards	Requirement	Category
6.6*	Coding system Preamble	[JIS X 6319-4] 5.2.4 6.2.1 [NFC Forum] 8.1.2	Each preamble must be sent in 48 bits.	M
6.7.3*	Format of the request command when only enabling e-money payments System Code Request Code Time Slot count	[JIS X 6319-4] 8.5.1, 8.5.2, 8.5.3, 8.5.4 [NFC Forum] 8.6.1	System Code (SC), Request Code (RC), and Time Slot must be correctly set in the Polling command sent from the Reader/Writer.	M
6.8.3*	Format of the request command when enabling e-money payments and performing peer-to-peer communication based on NFC-DEP(F)	[JIS X 6319-4] 8.5.1, 8.5.2, 8.5.3, 8.5.4 [NFC Forum] 8.6.1	System Code (SC), Request Code (RC), and Time Slot must be correctly set in the Polling command sent from the Reader/Writer.	C
6.8.4*	Format of a response when enabling e-money payments and performing peer-to-peer communication based on NFC-DEP(F)	[JIS X 6319-4] 8.6.1, 8.6.2, 8.6.3 [NFC Forum] 8.6.2	The first two Bytes of IDm in the Polling response sent from a device such as a smartphone must be checked to identify the device as T3T or NFC-DEP(F).	C
6.9	Guard time	[JIS X 6319-4] Appendix F.3 [NFC Forum] 8.7.4	The RF output must be turned on at least 30ms after it is turned off. The first FeliCa frame (such as the Polling command) must be sent at least 20.4 ms after the RF output is turned on.	M
6.10*	Frame structure	[JIS X 6319-4] 6.2 [NFC Forum] 8.1.3	The end of the frame is calculated by LEN and the coding state after CRC is ignored.	M

\* The following item number is allowed to inherit passing results from the NFC Forum test and be treated as passing for the Requirements.

- NFC Forum Certification Release (abbreviated to as *CR* hereafter) 11 acceptable products: 6.6 - 6.8.4 can be inherited.
- Passed products after the CR 12 of the NFC Forum: 6.10 can be inherited.

## 6.6. Coding system

### 6.6.1. Target to be checked

This item must be checked for all the samples of all the products to be submitted to the Certification Test.

### 6.6.2. Devices to be used for evaluation

Examples of devices to be needed in addition to the instruments in section 5.3 Instruments to be used for evaluation are as follows:

None.

### 6.6.3. Requirements

The preamble (SoS) in the Polling command sent from a sample must consist of 48 bits of pattern D or 48 bits of pattern E (see Figure 1 and Figure 2).

### 6.6.4. Measurement procedure

1. Place a probe over the antenna of your sample.
2. The sample sends the Polling command.
3. Use the instruments to analyze the bit string of the Polling command received via the probe.
4. Starting from the point when non-modulation changes to modulation, check the number of bits of the preamble within 48 *etu*.

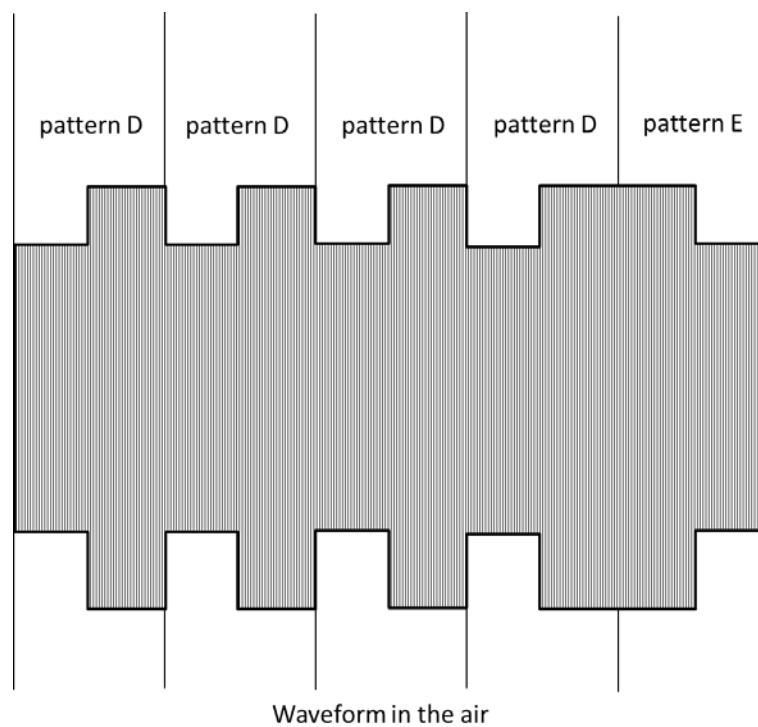
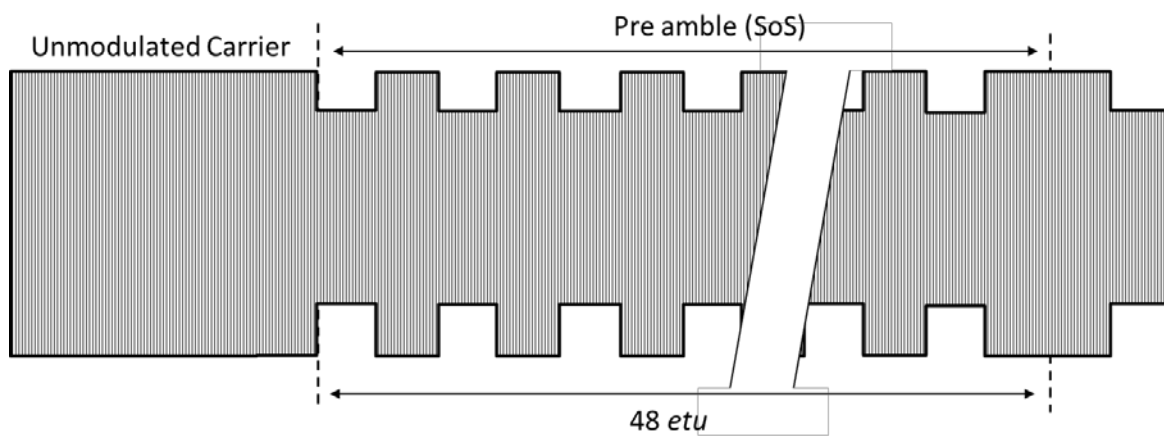

Figure 1



a) Positive polarity coding



b) Negative polarity coding

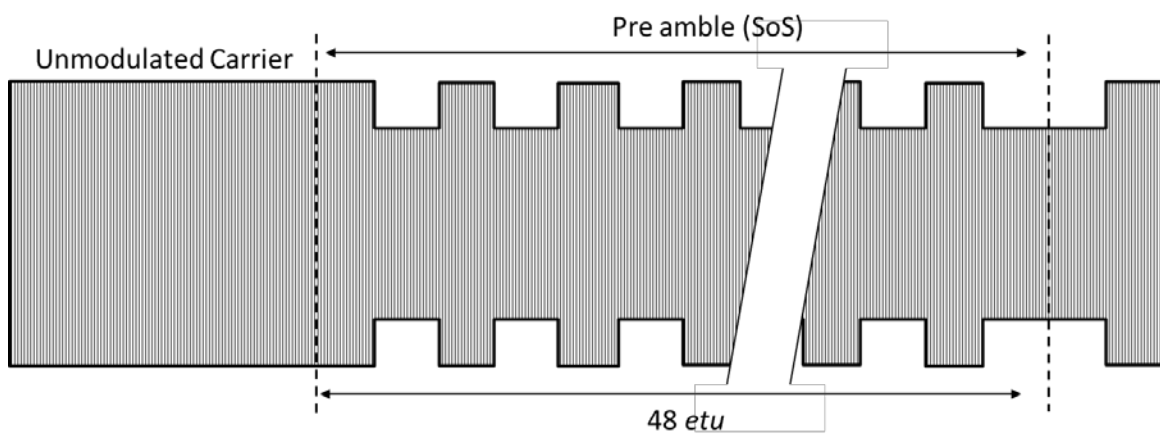

Figure 2

## **6.7. Command format for only enabling e-money payments**

### **6.7.1. Target to be checked**

This item must be checked for all the samples of all the products to be submitted to the Certification Test.

### **6.7.2. Devices to be used for evaluation**

Examples of devices to be needed in addition to the instruments in section 5.3 Instruments to be used for evaluation are as follows:

T3T devices (such as smartphones that can handle e-money payments in Japan and IC cards)

### **6.7.3. Format of the request command**

#### **6.7.3.1. Requirements**

Check that System Code, Request Code, and Time Slot are correctly set in the Polling command (see Table 1).

Check the type of System Code in Table 1. Based on the type of System Code, check Figure 3 Sequence 1 for only enabling e-money payments or Figure 4 Sequence 2 for only enabling e-money payments to see if your sample and the target T3T device behave as described in either figure.

#### **6.7.3.2. Measurement procedure**

1. Place a T3T device over the antenna of your sample.
2. The sample sends the Polling command.
3. Observe the Polling command and check whether the sent command contains Request Code appropriate for System Code.

Note: Enter System Code and Request Code used during the evaluation in the Check Sheet.

**Table 1 Combinations of System Code and Request Code for only enabling e-money payments**

System Code	Request Code	Polling response	Applicable sequence figure
Other than FFFF	Any	T3T (the first two Bytes of IDm must be other than 01FE)	Figure 3
FFFF	01	T3T (the first two Bytes of IDm must be other than 01FE)	Figure 4

Sequence 1: Only enabling e-Money payments

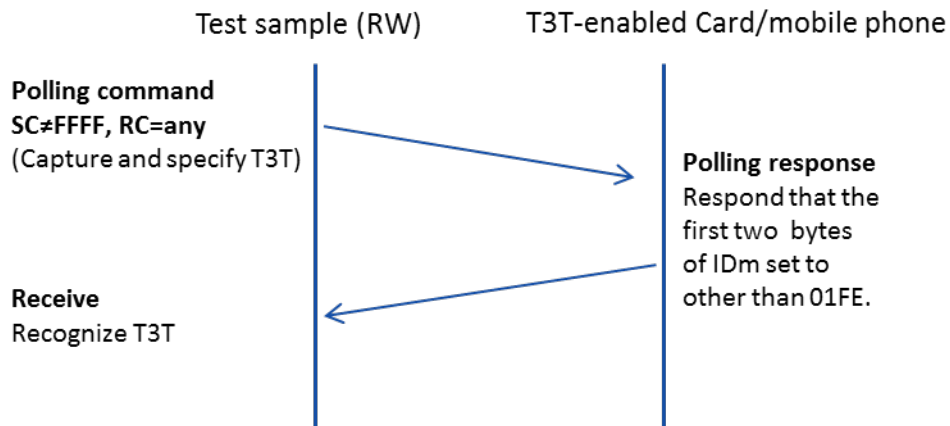

**Figure 3**

Sequence 2: Only enabling e-Money payments

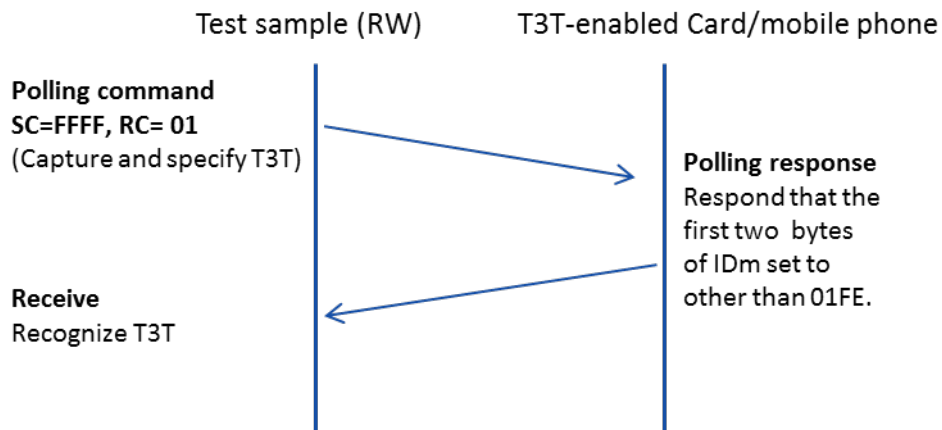

**Figure 4**

## **6.8. Command format for enabling e-money payments and performing peer-to-peer communication based on NFC-DEP(F)**

### **6.8.1. Target to be checked**

This item must be checked for the samples of the products to be submitted to the Certification Test if they support NFC-DEP(F) and send the Polling command with FFFF as System Code.

### **6.8.2. Devices to be used for evaluation**

Examples of devices to be needed in addition to the instruments in section 5.3 Instruments to be used for evaluation are as follows:

T3T devices and devices that support NFC-DEP(F) (such as smartphones sold outside Japan. In this case, the HCE-F application or NFC-F-compatible SIM cards (such as commercial SIM cards available in Hong Kong) are needed. HCE-F begins to be supported in Android 7.0)

### **6.8.3. Format of the request command**

#### **6.8.3.1. Requirements**

Check that System Code, Request Code, and Time Slot are correctly set in the Polling command (see Table 2 and Figure 5).

#### **6.8.3.2. Measurement procedure**

1. Place a T3T/NFC-DEP(F) device over the antenna of your sample.
2. The sample sends the Polling command.
3. Observe the Polling command and check whether the sent command contains FFFF as System Code and 00 as Request Code for technology discovery.
4. After the sample receives the Polling response from the T3T/NFC-DEP(F) device using NFC-DEP(F), check whether the sample sends the Polling command containing FFFF as System Code and 00 as Request Code. This step is to determine whether the device is NFC-DEP(F) or T3T.
5. After the sample receives the Polling response from the T3T/NFC-DEP(F) device using NFC-DEP(F), check whether the sample sends the Polling command containing FFFF as System Code and 01 as Request Code. This step is to capture and identify a T3T signal.

### **6.8.4. Format of a response**

#### **6.8.4.1. Requirements**

Check the first two Bytes of IDm in the Polling response returned from a T3T/NFC-DEP(F) device and make sure that you can identify the device as NFC-DEP(F) or T3T (see Figure 5).

### 6.8.4.2. Measurement procedure

1. Place a T3T/NFC-DEP(F) device over the antenna of your sample.
2. The sample sends the Polling command containing FFFF as System Code and either Request Code listed in Table 2.
3. After the sample receive the Polling response from the T3T/NFC-DEP(F) device, check the FeliCa frame sent from the sample.

**Table 2 Combinations of System Code and Request Code for enabling e-money payments and performing peer-to-peer communication based on NFC-DEP(F)**

System Code	Request Code	Polling response	Applicable sequence figure
FFFF	00	NFC-DEP(F) (the first two Bytes of IDm must be 01FE)	Figure 5
FFFF	01	T3T (the first two Bytes of IDm must be other than 01FE)	Figure 5

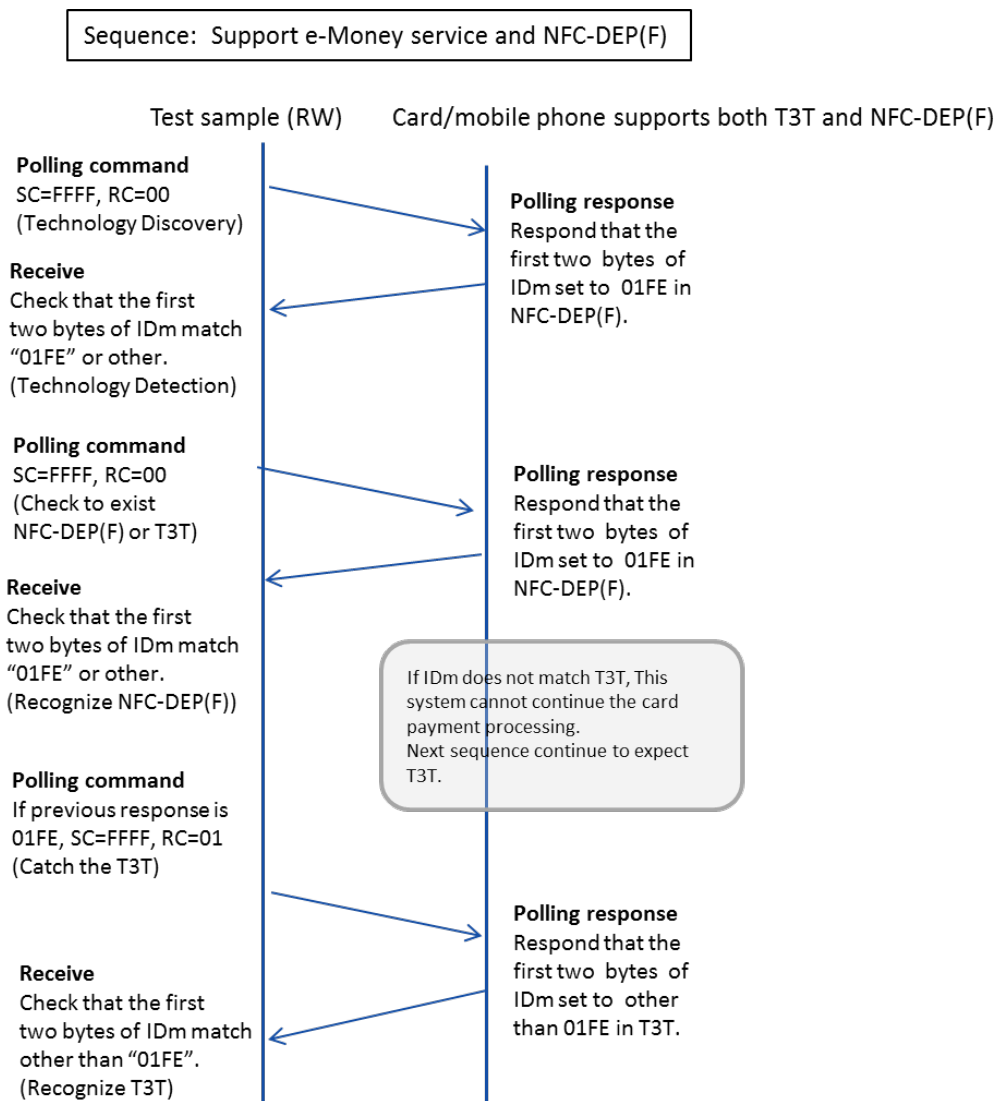

**Figure 5**

## 6.9. Guard time

### 6.9.1. Target to be checked

This item must be checked for all the samples of all the products to be submitted to the Certification Test.

### 6.9.2. Devices to be used for evaluation

Examples of devices to be needed in addition to the instruments in section 5.3 Instruments to be used for evaluation are as follows:

None.

### 6.9.3. Requirements

The RF output must be turned on at least 30 ms after it is turned off. Even if your sample is received the command to turn on the RF output by applications, the sample should wait to turn on the RF output until at least 30ms.

The first command must be sent at least 20.4 ms after the RF output is turned on.

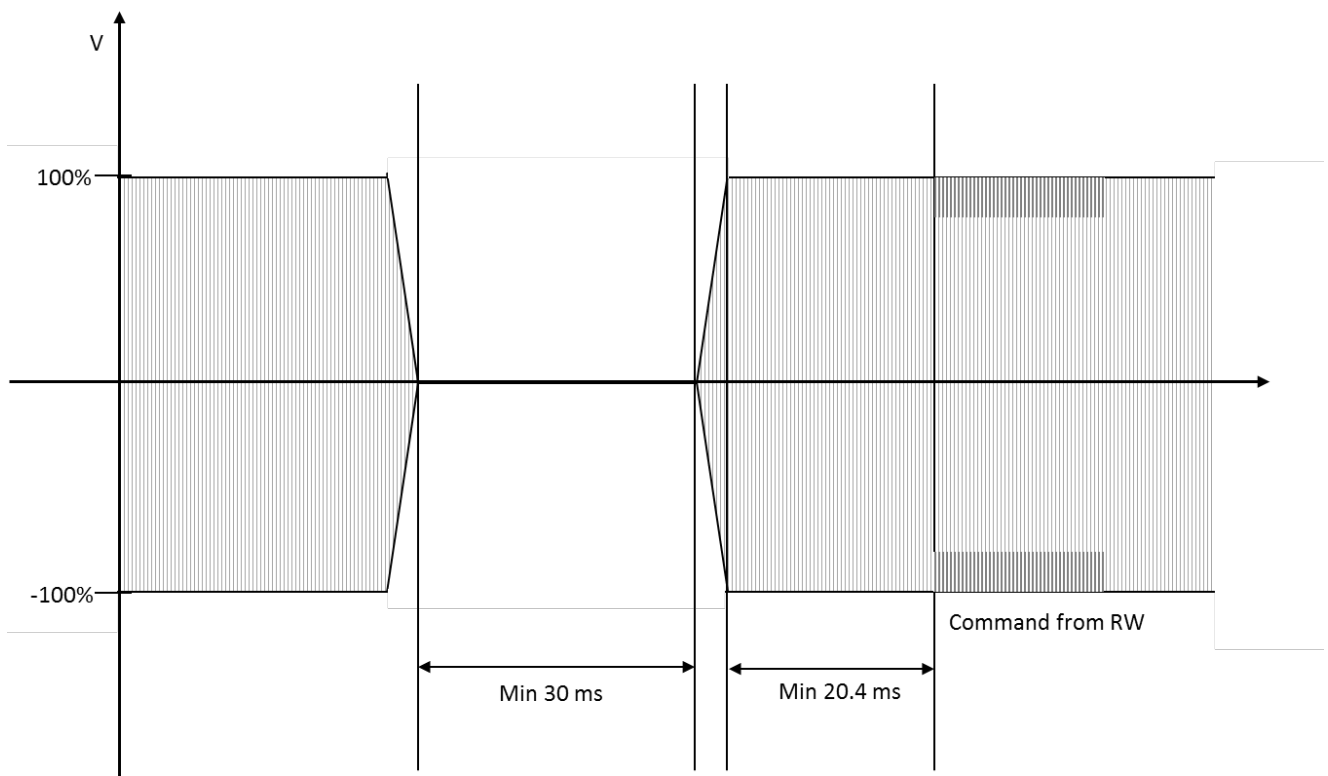

Figure 6

### 6.9.4. Measurement procedure

1. Place a probe over the antenna of your sample.
2. The sample sends the Polling command.
3. The sample turns off the RF output and then turns it off.
4. Use appropriate instruments via the probe to measure the off period and on period of the RF output.

## 6.10. Frame structure

### 6.10.1. Target to be checked

This item must be checked for all the samples of all the products to be submitted to the Certification Test.

### 6.10.2. Devices to be used for evaluation

Examples of devices to be needed in addition to the instruments in section 5.3 Instruments to be used for evaluation are as follows:

None.

### 6.10.3. Requirements

The sample to be inspected shall transmit each command (odd number) according to the sequence shown in Table 3, and be able to correctly receive all the responses (even number) including the frame configurations of the following six patterns (a to f) returned from the DP TestBoard.

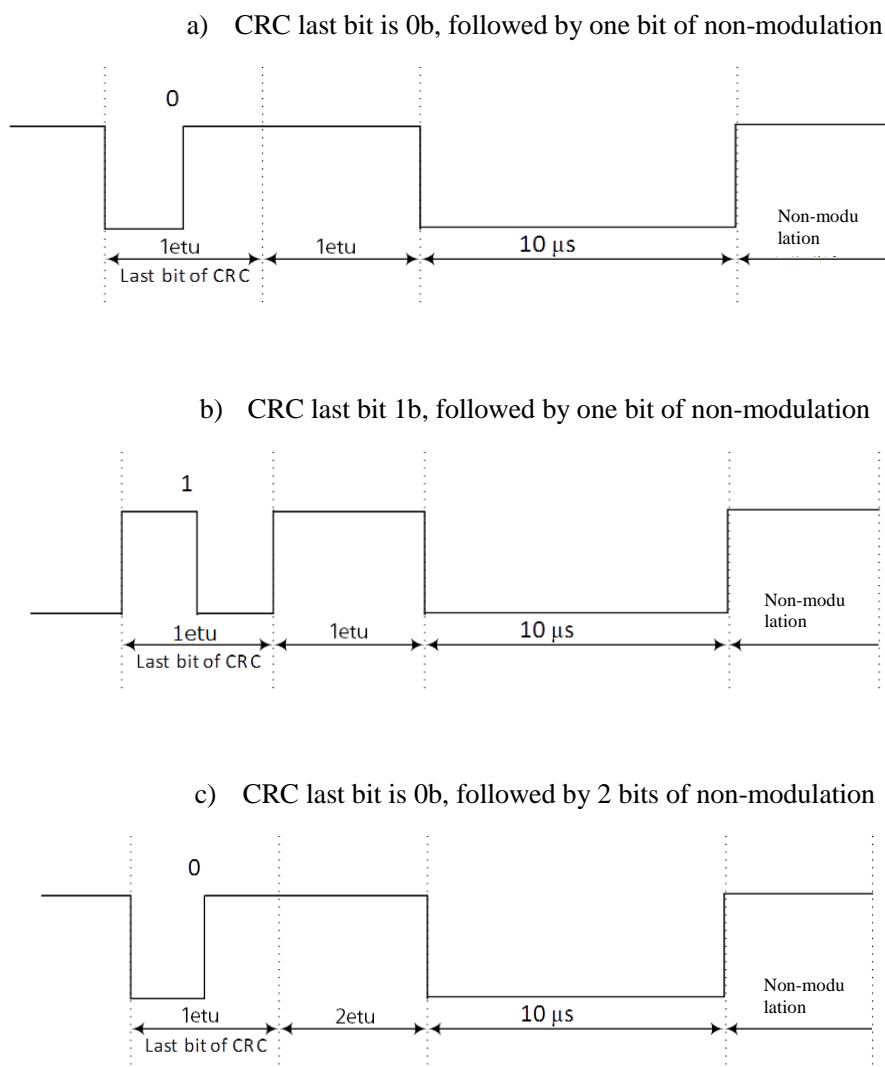
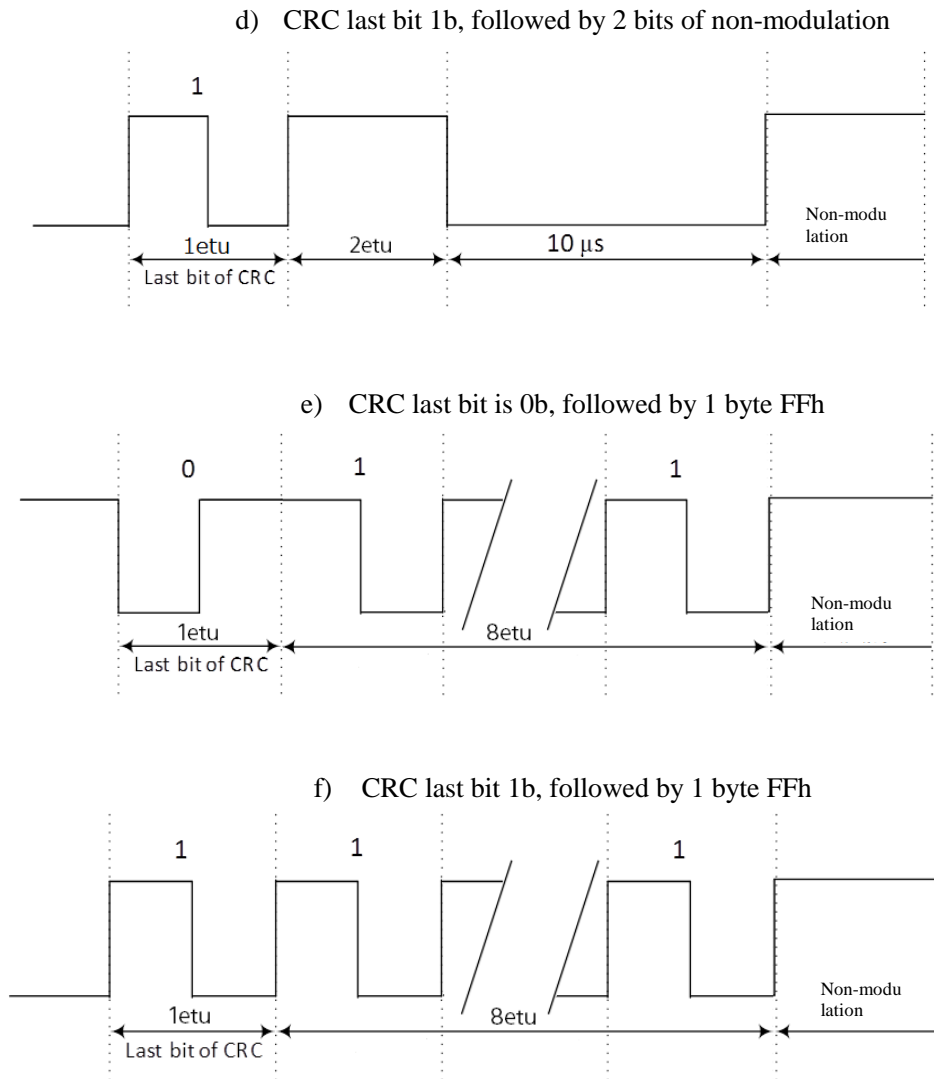

Figure 7



**Figure 8**







#### **6.10.4. Measurement procedure**

1. Connect a DP TestBoard\* to the MicroB terminal of the USB cable.
2. The other terminal of the USB cable is connected to a power supply device with a USB terminal that can supply 500 mA.
3. Put a DP TestBoard on the antenna of the Reader / Writer sample.
4. The command No. 1 in Table 4 is transmitted from the Reader / Writer sample to the DP TestBoard, and the DP TestBoard is set to "212 kbps" and "positive encoding".
5. When the Reader /Writer sample transmits commands in accordance with the sequence shown in Table 3, the Reader / Writer sample is inspected to receive all responses from the DP TestBoard.
6. The command No. 2 in Table 4 is transmitted from the Reader / Writer sample to the DP TestBoard, and the DP TestBoard is set to "212 kbps" and "negative encoding".
7. When the Reader /Writer sample transmits commands in accordance with the sequence shown in Table 3, the Reader / Writer sample is inspected to receive all responses from the DP TestBoard.

\* Refer to the operation manual for detailed setting of the DP TestBoard.

## Attachment A: Digital protocol requirements check sheet

We guarantee that the following requirements have been satisfied.

Date of application: \_\_\_\_\_

### Applicant information

Company name: \_\_\_\_\_

### Applicant

Applicant name: \_\_\_\_\_ Signature \_\_\_\_\_

E-mail address: \_\_\_\_\_

Department: \_\_\_\_\_

### Authorization

Authorized by: \_\_\_\_\_ Signature: \_\_\_\_\_

Title: \_\_\_\_\_

### Information on the product to be tested

Model of the product: \_\_\_\_\_

Enter the certification number if the product is an NFC Forum certified device.

CR Ver: \_\_\_\_\_ Certification ID: \_\_\_\_\_

**If the Requirements are satisfied, circle YES in the Check column in the following table.**

The following items are for all the samples of all the products to be submitted to the Certification Test.

No.	Item	Functionality	Category	Check
6.6	Coding system	Are all preambles sent in 48 bits?	M	<b>YES</b>
6.7.3	Request command format for only enabling e-money payments	Are System Code, Request Code, and Time Slot correctly set in the Polling command sent from the Reader/Writer? <u>Note: Specify the sequence figure, System Code, and Request Code chosen for the evaluation.</u>	M	<b>YES</b> <b>Fig. 3 or Fig. 4</b> <b>SC= _____</b> <b>RC= _____</b>
6.9	Guard time	Is the RF output turned on at least 30 ms after it is turned off? Is the first FeliCa frame sent at least 20.4 ms after the RF output is turned on?	M	<b>YES</b>
6.10	Frame structure	The end of the frame is calculated by LEN and the coding state after CRC is ignored.	M	<b>YES</b>

**The following question determines whether your product falls into the category of Conditional. Circle either answer.**

Do your samples support NFC-DEP(F)?	<b>YES      or      NO</b>
-------------------------------------	----------------------------

If the answer is YES, also check the following for your samples (which support NFC-DEP(F)).

No.	Item	Functionality	Category	Check
6.8.3	Request command format for enabling e-money payments and performing peer-to-peer communication based on NFC-DEP(F)	Are System Code, Request Code, and Time Slot correctly set in the Polling command sent from the Reader/Writer?	C	<b>YES</b>
6.8.4	Response format for enabling e-money payments and performing peer-to-peer communication based on NFC-DEP(F)	Do the first two Bytes of IDm in the Polling response sent from devices such as smartphones indicate T3T or NFC-DEP(F)?	C	<b>YES</b>